

## Installation Manual for VHM-25™ Series Arms Channel Mount



**Install Time:** 10-15 minutes

*The purpose of this manual is to describe general installation and adjustment procedures for VHM-25™ Series Arms. This manual should be used in conjunction with any instrument-specific installation guides used in mounting the monitor or display. Please read this manual and all instrument-specific installation material before installing or using this product.*

### Table of Contents

1.0	Parts Reference.....	1
2.0	Tools Required.....	2
3.0	Installation and Maintenance Warnings.....	2
4.0	Installing the VHM-25 Arm in a GCX Channel .....	3
5.0	Mounting a Display on the VHM-25 Arm .....	4
6.0	Adjusting the VHM-25 Arm .....	5
7.0	Cable Management.....	7
8.0	Installing the Channel Cover.....	8
9.0	Routine Maintenance.....	9
10.0	Cleaning the VHM-25 Arm.....	9
11.0	Troubleshooting the VHM-25 Arm.....	10

### 1.0 Parts Reference

The following parts and hardware are included with this installation kit and labeled accordingly:

Item #	Description	Qty
1	VHM-25 Channel Mount Arm	1
2	1/8", 5/32", and 2.5mm Hex Wrench	1 Ea.
3	M4 x 6,8,10,12,16,20,25,30mm Pan Head Machine Screws (PHMS)	4 Ea.
4	Nylon Spacers (3/8" x 1/2") and (3/8" x 5/8")	4 Ea.
5	Adjustable Stop	1
6	16 in. [40.6 cm] Wall Channel Cover (includes instructions)	1
7	M4 x 16mm Flat Head Socket Cap Screw (FHSCS)	2

## 2.0 Tools required

The tools listed below are required to install and adjust the VHM-25.

### Provided

- 1/8" Hex Wrench
- 5/32" Hex Wrench
- 2.5mm Hex Wrench

### Not Provided

- #2 Phillips Screwdriver
- 1/2" (13mm) Socket Wrench
- 3/4" (19mm) Socket Wrench
- 1/2" Open End Wrench
- Scissors, utility knife or similar cutting tool

## 3.0 Installation and Maintenance Warnings

This section contains warnings regarding the installation and maintenance of the VHM-25 Arm. This section must be read in its entirety before installing and maintaining the VHM-25 Arm. Failure to follow these warnings may result in damage to equipment or injury to personnel.



### Warnings

- Do not position the VHM-25 Arm or mounted display above a patient. Note that the VHM-25 Arm has a wide range of motion both up/down and side to side. Please consider carefully the display being mounted and the proximity of the mounting assembly to other equipment, hospital personnel, and the patient. GCX recommends that the hospital's risk management personnel verify that the application is appropriate prior to installation and use of the VHM-25 Arm.
- Before the VHM-25 Arm is channel mounted, verify that the channel has been installed and approved in accordance with the channel installation guide. [www.gcx.com / Support / Wall Channel Installation](http://www.gcx.com/Support/WallChannelInstallation).
- Ensure that the weight of the display being mounted is within the weight limit of the VHM-25 Arm – Refer to labeling on the VHM-25 Arm.
- Do not use power tools to make any adjustments on VHM-25.
- The mounted device or arm may move suddenly due to normal wear or improper adjustment of the tilt and swivel functions (see Sections 6.2 and 6.3), improper counterbalance (Section 6.1) or ultimately, gas spring end of life. The gas spring has a limited life span and will lose some strength over a long period of time. The VHM-25 Arm must be inspected and maintained at least once a year. This inspection must include the steps outlined in Section 9.0.
- Due to risk of personal injury or damage to the equipment, the VHM-25 Arm housing must never be disassembled by non-GCX personnel. Failure to comply will void the warranty.
- Note that the VHM-25 Arm has a wide range of motion both up/down and side to side. Please consider potential Pinch Points that may cause personal injury.

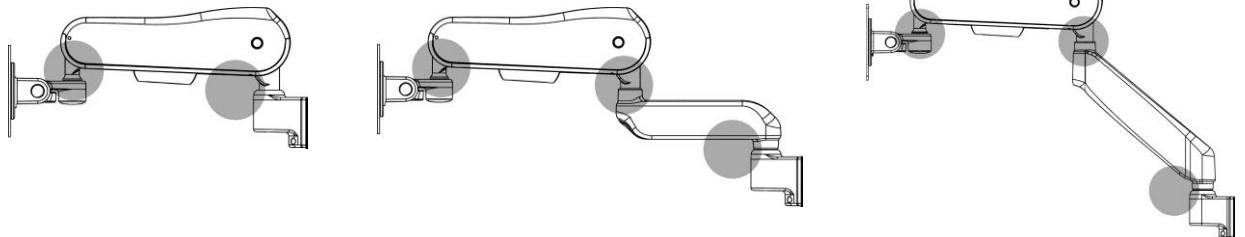

- Remove the display only when the VHM-25 Arm is at the highest position. Due to the counter balance function, the VHM-25 Arm will naturally rise to the highest position when weight is removed. This can happen suddenly if the weight is removed at any height other than the highest point.

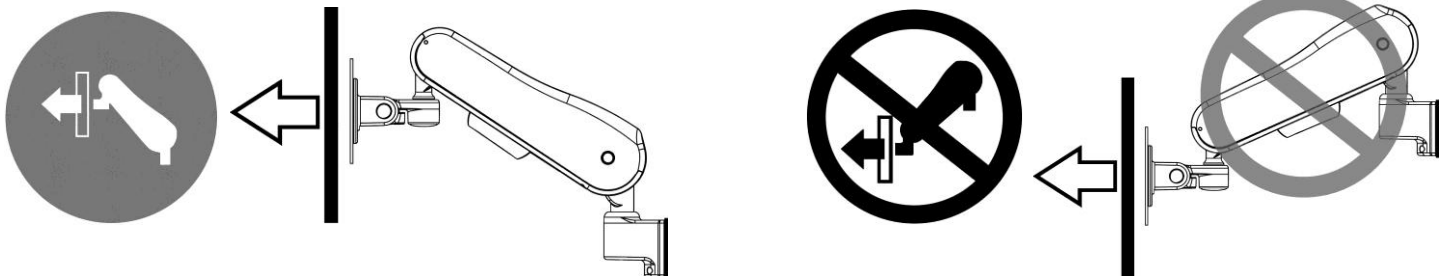

## 4.0 Installing the VHM-25 Arm in a GCX Channel

- 4.1 Install Adjustable Stop in top of Channel, and slide to desired mounting position. Making sure the Adjustable Stop is level, tighten center screw with a #2 Phillips screwdriver to secure position.

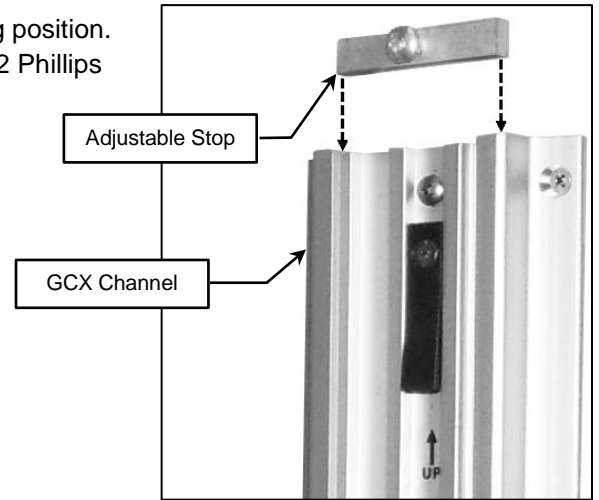

- 4.2 While supporting the bottom of the VHM-25 Arm, guide the Slide into the top of the Channel (right) and position it against the Adjustable Stop.

**Installation Note:** The VHM-25 Arm with Extension may require additional support under the extension while mounting in channel (below).

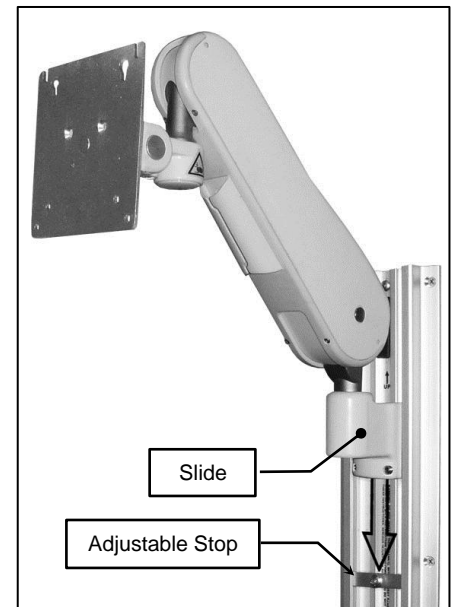
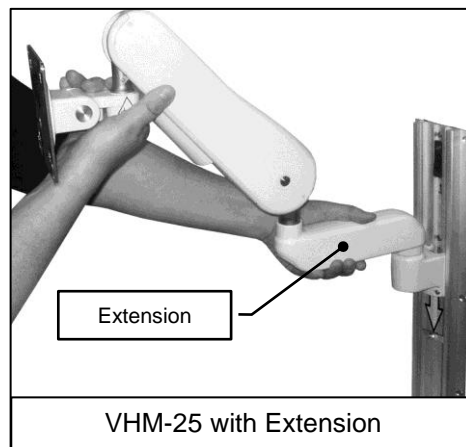

- 4.3 Using a 1/8" hex wrench (supplied), tighten (CW) the (2) set screws in the Slide to secure position of Arm.

**Installation Note:** There will be resistance when turning the (2) Set Screws due to the locking patch material on the threads. The screw tips must be driven against the channel to secure the Arm.

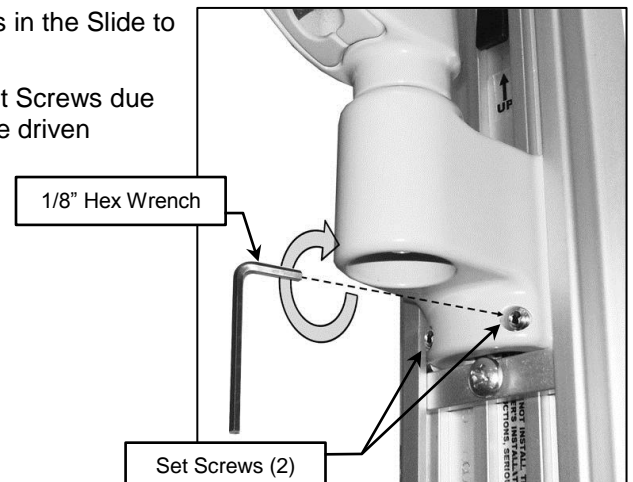

## 5.0 Mounting a Display on the VHM-25 Arm

**WARNING:** This mounting kit provides an assortment of hardware for a wide variety of display-mounting applications. It is the responsibility of the installer of this product to ensure that all screws used to mount the display have a minimum thread engagement of (4) 360° turns into threaded inserts in the rear of display when mounted. It is also the responsibility of the installer to ensure that screws are not inserted too far into the display, causing damage to internal components. Failure to adhere to this warning could result in damage to equipment or injury to patients or personnel.

**Installation Note:** If the VESA mounting pattern is located in a recessed area of the display in which the VESA Mounting Plate will not fit, See *Using Nylon Spacers* (below), then follow mounting procedures on this page.

- 5.1 Optional: Locking the VESA rotation function-** The mounted display can be rotated 90° from landscape to portrait (see section 6.6). If this function is not needed for the installation, it can be locked out by installing the optional VESA Rotation Lock Screws prior to installing the display (see diagram at right). To install these screws, rotate the VESA Mounting Plate to the orientation shown and align the holes in the VESA plate with the threaded holes in the housing behind it. Next, install the (2) M4 x 16mm FHSCS using a 2.5mm hex wrench (provided).

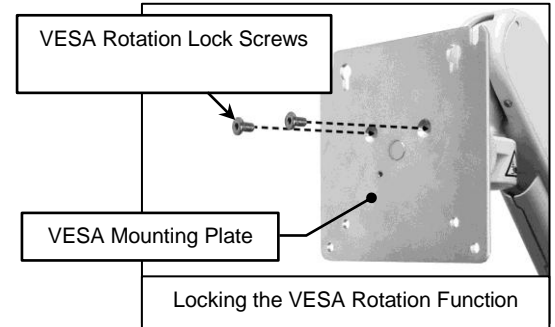

- 5.2** Thread (2) M4 Pan Head screws into the top (2) threaded holes of the VESA mounting pattern located on the back of the display, leaving 4mm of thread exposed. Lift display onto VESA Mounting Plate by guiding the M4 Pan Head screws into the (2) slots in top of Plate (100mm x 100mm VESA pattern), or through the (2) Keyholes (75mm x 75mm VESA pattern). Thread (2) M4 Pan Head screws into lower mounting holes. **Tighten all screws to secure.** To help prevent stripping the M4 screws in this procedure, use a # 2 Phillips screwdriver. Procedure is the same for both mounting plate types.

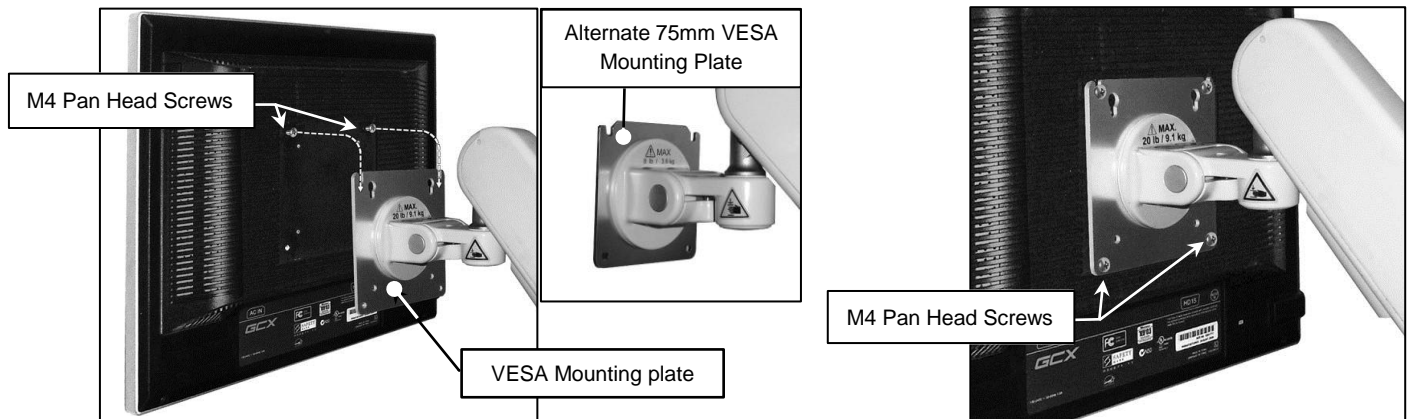

- 5.3 Using Nylon Spacers-** An assortment of Nylon Spacers and longer M4 Pan Head screws (see *Parts Reference on page 1*) are included for extending the VESA Mounting Plate out of a recessed mounting area in a display housing. Select the appropriate length Nylon Spacers and M4 Pan Head screws to mount the display with a minimum of (4) 360° turns of thread engagement. An additional person may be needed to hold the display when installing the Nylon Spacers between the display and the VESA Mounting Plate. To help prevent stripping the M4 screws in this procedure, use a # 2 Phillips screwdriver. Procedure is the same for both mounting plate types.

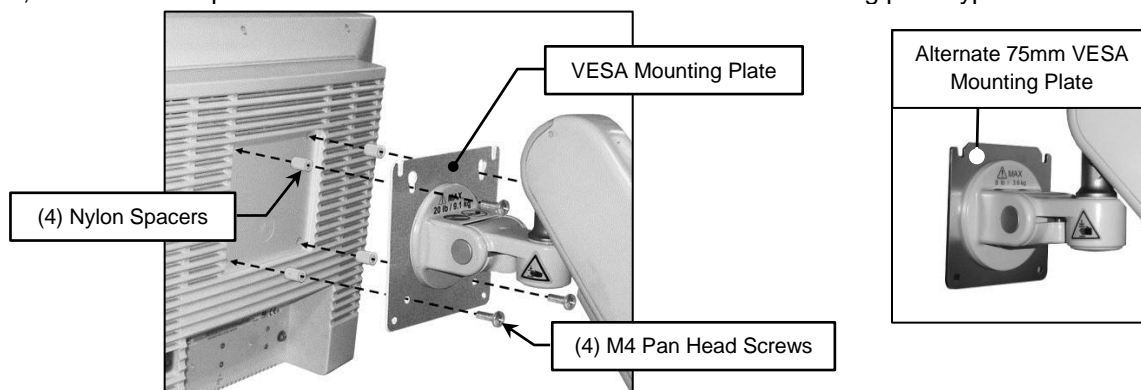

## 6.0 Adjusting the VHM-25



**Caution:** Before the VHM-25 arm is properly counterbalanced, be sure the weight of the display on the arm can be supported while setting the counterbalance. Use more than one person if required. Some of the following pictures do not show the mounted display for detail purposes.

**Installation Note:** Adjustments are factory pre-set. Adjustments to counterbalance, tilt tension and pivot tensions may all be required to achieve a proper installation. Detailed instructions for making adjustments follow in the section below. When properly adjusted the mounted display will "float" throughout the height range and can be positioned safely and with a desired feel throughout the full range of motion. Refer to the Routine Maintenance Check List, section (9), for a quick guide to these functional checks.

- 6.1 Counterbalance Adjustment** – Grasp the mounted display and move the Arm to a level horizontal position. Using a 1/8" hex wrench, tighten (+) or loosen (-) the Adjustment Screw. The Adjustment Screw is located under the rear pivot point on the VHM-25, and under the center pivot point on the VHM-25 with Extension. Counterbalance is correctly adjusted when the mounted instrument can be moved up or down with minimal force and does not rise or fall after releasing the Arm. The full range of adjustment is approximately 18 turns.

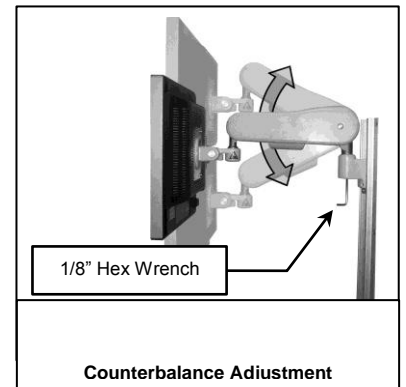
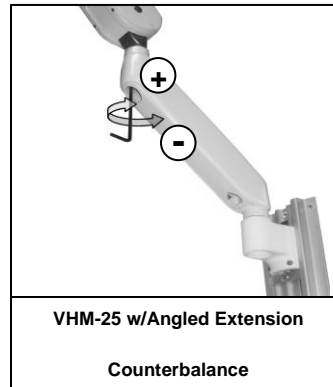
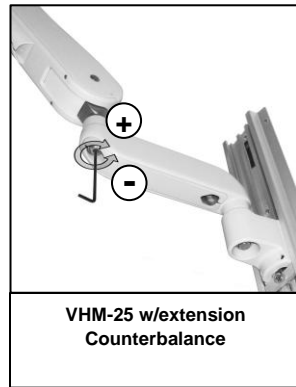
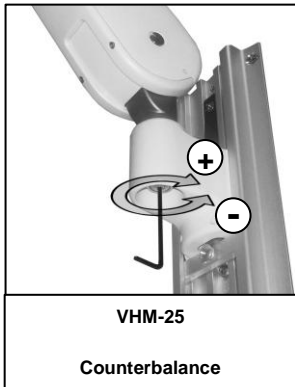

- 6.2 Tilt Tension Adjustment** – Using a 5/32 hex wrench, tighten (+) or loosen (-) the Tilt Tension Adjustment Screw until desired Tilt Tension is achieved. Adjustment range is approximately 1/2 turn total. Do not remove or over-torque the Adjustment Screw.

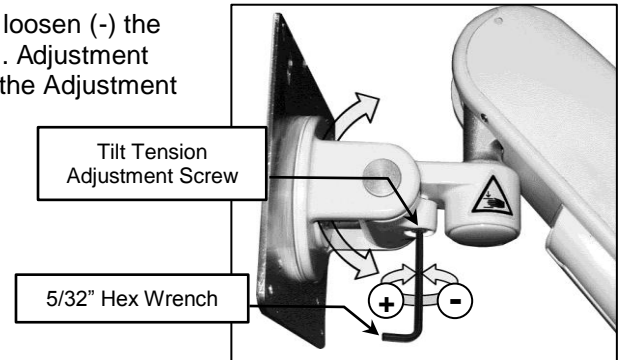

- 6.3 Swivel Tension Adjustment** – Remove the Swivel Cap by inserting the end of the 1/8" hex wrench into the Swivel Cap and rotating outward (Fig. A) or by pulling straight down on the Cap (Fig. B). Tighten (+) or loosen (-) the Swivel Tension Nut with a 1/2" or a 13 mm socket wrench until desired tension is achieved (Fig. C). Do not remove the Swivel Tension Nut. Total adjustment is approximately 1/2 turn. Snap Swivel Cap back into place.

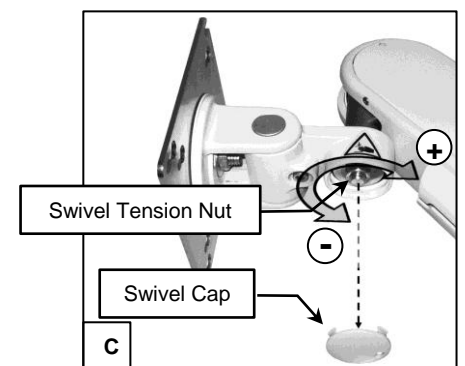
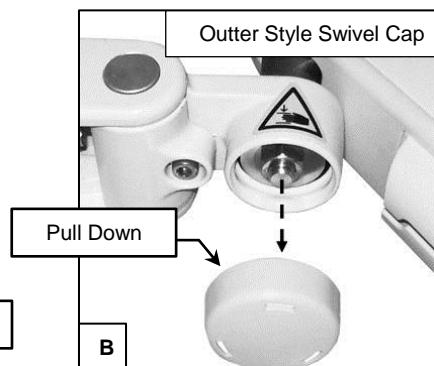
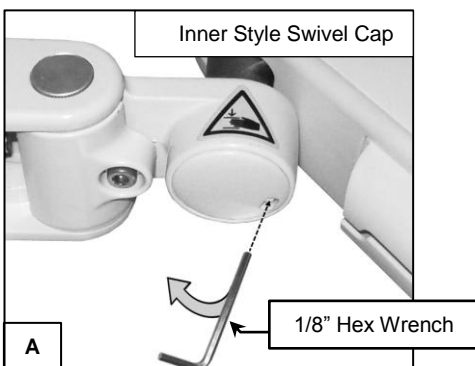

**6.4 Rear Pivot Tension Adjustment** – To adjust the tension at the rear Pivot Point (closest to channel), tighten (+) or loosen (-) the Pivot Tension Nut with a 3/4" or a 19 mm socket wrench until desired tension is achieved. Do not remove the Pivot Tension Nut.

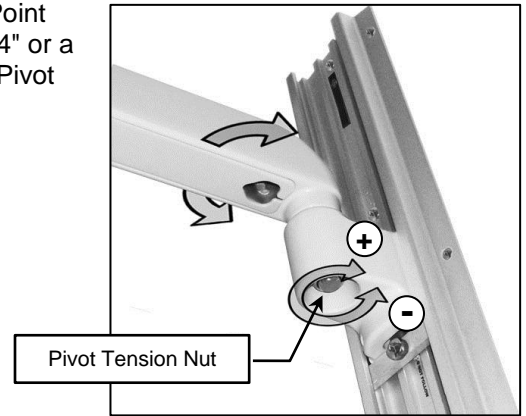

**6.5 Center Pivot Tension Adjustment (VHM-25 with Extension)**- Insert finger into the front of the Cable Cover and pull down to remove (Fig. A). Tighten (+) or loosen (-) the Pivot Tension Nut with a 3/4" or a 19 mm socket wrench until desired tension is achieved (Fig. B). Push Cable Cover up into the Arm until the tabs on the side of the Cable Cover snap into place (Fig. C). Do not remove the Pivot Tension Nut.

**Installation Note:** For optimal Arm performance and ease of movement, the rear pivot tension should be adjusted slightly tighter than the center pivot tension (VHM-25 with extension only).

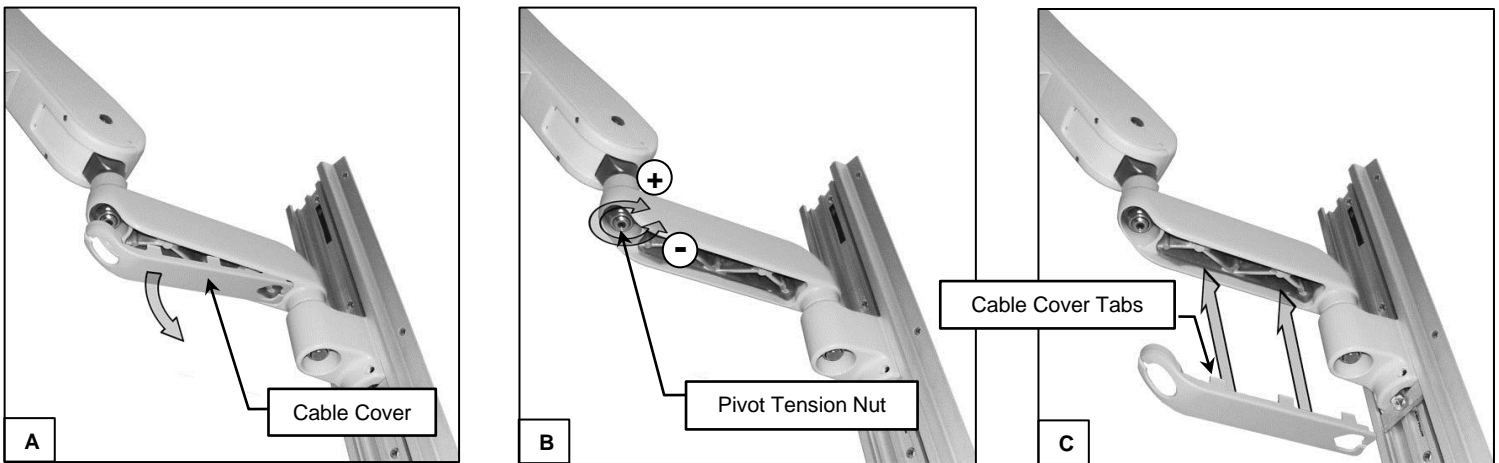

**6.6 VESA Rotation Tension Adjustment**

**Installation Note:** This section does not apply if VESA mounting plate is locked. See Section 5.1 for details.

The display can be rotated 90° from landscape to portrait (A-B) by grasping the sides of the display and rotating CCW. The rotation tension can be adjusted by tightening (+) or loosening (-) the Rotation Tension Nut with a 1/2" or 13mm open end wrench (Fig. C). Total adjustment range is approximately 1/2 turn. Do not remove the Rotation Tension Nut.

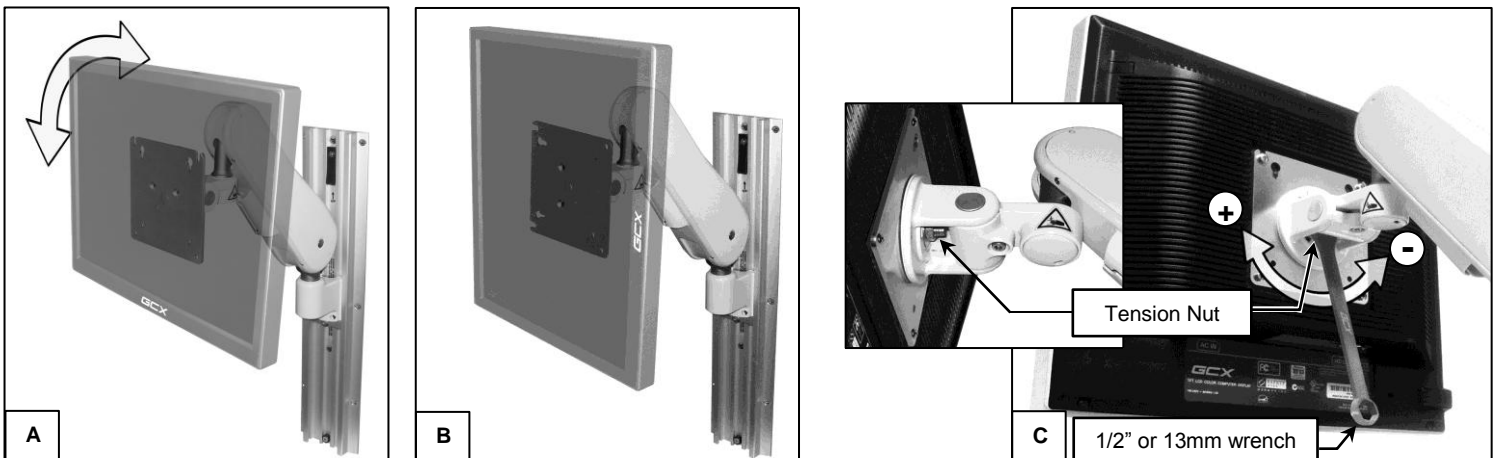

## 7.0 Cable Management

**7.1 VHM-25 Cable Management-** The VHM-25 has two cable management features that allow placement and routing of cables.

**7.1.1** A flexible Cable Guide beneath the arm manages cables going between the front and rear of the arm. To install cables, use your thumb and press cables through the center seam of the Cable Guide (see Fig. A below).

**7.1.2** A “pass-through” channel slide allows cables to run behind the arm within the channel. **Note:** If cable connectors are too large to fit through the pass-through, try placing the cables in the path of the Slide before installing the arm in the channel.

 **Caution:** Keep fingers outside of Cable Guide when installing cables.

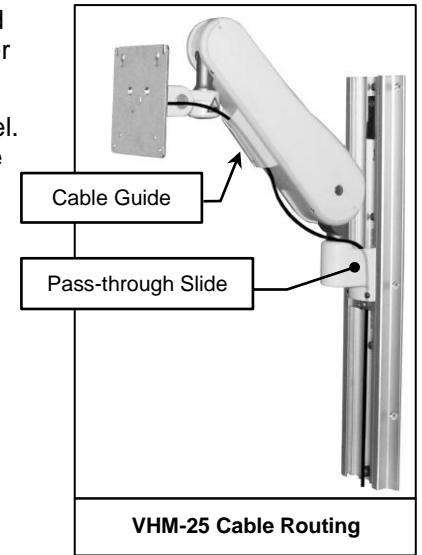
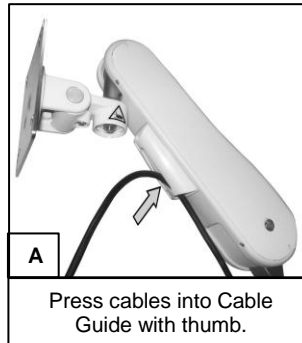

**7.2 VHM-25 w/ Extension Cable Management-** The VHM-25 w/ Extension has three cable management features that allow placement and routing of cables.

**7.2.1** A Flexible Cable Guide beneath the arm manages cables going between the front of the Arm and the Extension. To install cables, use your thumb and press cables through the center seam of the Cable Guide (see Fig. A above).

**7.2.2** An open cavity beneath the extension with a removable Cable Cover manages cables going between the Arm and the pass-through slide. To install cables, remove Cable Cover by inserting finger into the front of the Cable Cover and pulling down (Fig. B). Push Cables into Cable Cover access holes as shown (Fig. C). Reinstall Cable Cover by pushing it up into the Arm until it snaps into place (Fig. D).

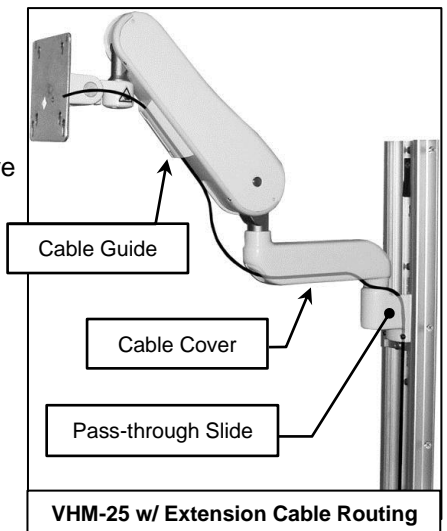
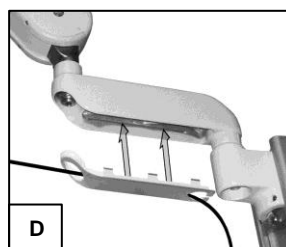
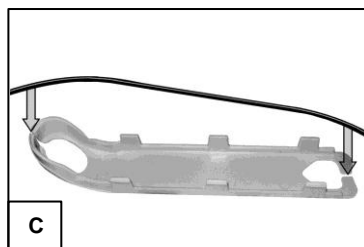
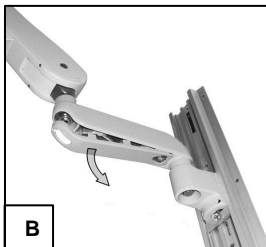

**7.2.3** A “pass-through” channel slide allows cables to run behind the arm within the Channel. **Note:** If cable connectors are too large to fit through the pass-through, try placing the cables in the path of the Slide before installing the arm in the Channel.



**Warning:** Route cables away from potential pinch points. A service loop of cable may be needed to accommodate all motion and to prevent cable binding, connector damage, or Cable Guide damage.

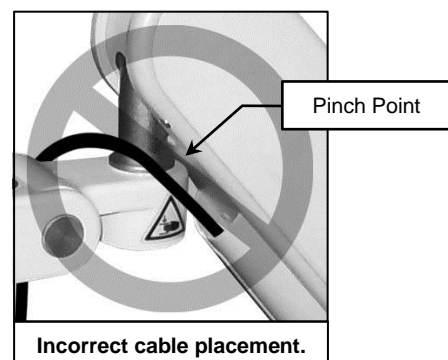
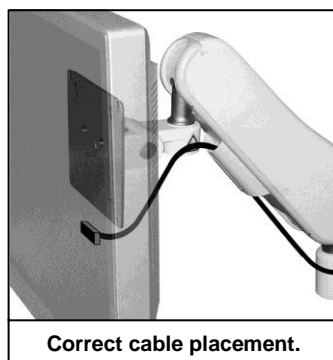

## 8.0 Installing the Channel Cover

The Channel Cover provides an aesthetic cover and may be used for cable management along the Channel.

- 8.1** Cut Channel Cover with scissors for a custom fit (below left). The back side of the Cover is scored in sections for easier cutting, or may be cut as required anywhere along the Cover. Scored notches are also provided for routing cables through the side of Cover if required. Using a utility knife, or similar cutting tool, cut along the scored line to create a cable-routing notch (below center and right).

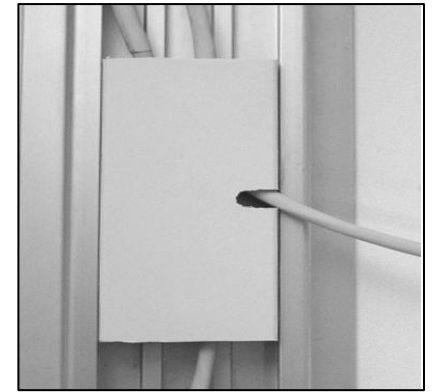
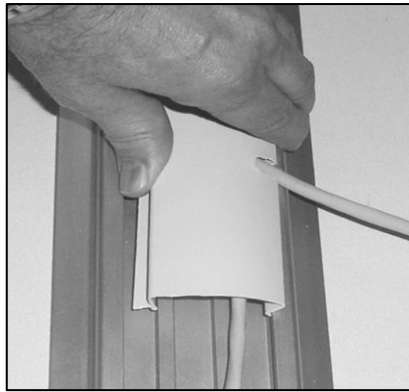
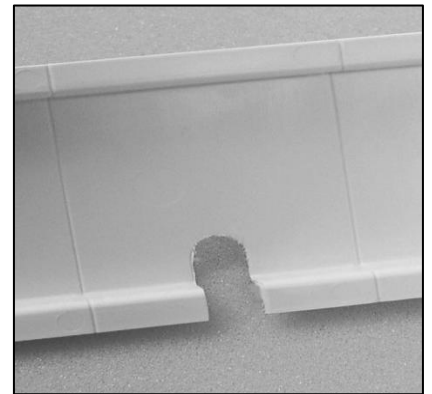
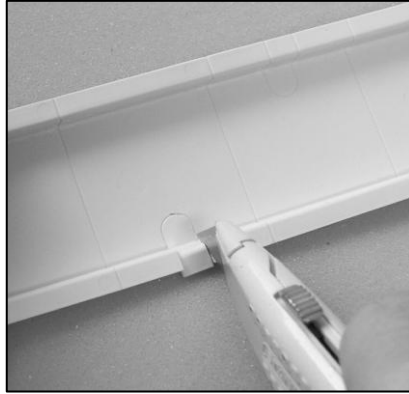
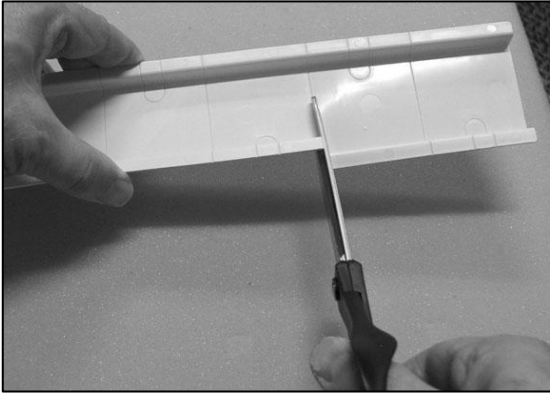

- 8.2** Press one side of the Cover into channel, routing cables behind Cover and through notches. Squeeze Cover and insert other side into channel.



## 9.0 Routine Maintenance

The VHM-25 Arm must be inspected and adjusted at least once a year. This inspection must include the steps listed in the Check List below:

✓	Routine Maintenance Check List	Section
	With the display mounted, move the arm through its entire vertical range of motion. The load should maintain its position at every point in the travel of arm. If necessary, the counterbalance mechanism may be adjusted.	6.1
	Grasp the mounted display and tilt it forward and back, through its entire range of motion. There should be enough tension or resistance in the tilt mechanism to prevent the display from tilting forward unexpectedly when in use. If necessary, the tilt tension may be adjusted.	6.2
	Grasp the mounted display and swivel it from side to side. The display should swivel with some tension or resistance, not loosely. If necessary, the swivel tension may be adjusted.	6.3
	Grasp the Arm and pivot it from side to side at the rear attachment. The arm should pivot with some tension or resistance, not loosely. If necessary, the pivot tension may be adjusted.	6.4
	Grasp the Arm (VHM-25 with Extension) and pivot it from side to side at the center attachment. The arm should pivot with some tension or resistance, not loosely. If necessary, the pivot tension may be adjusted.	6.5
	Grasp the sides of the display and rotate it from right to left (If not locked out <b>Sec. 5.1</b> ). The display should rotate with some tension or resistance, not loosely. If necessary, the rotation tension may be adjusted.	6.6
	Inspect fasteners for looseness. Tighten as required for optimal operation and safety.	4.1,4.3, 5.1, 5.2,5.3

## 10.0 Cleaning the VHM-25 Arm

The VHM-25 Arm may be cleaned with most mild, non-abrasive solutions commonly used in the hospital environment (e.g. diluted bleach, ammonia, or alcohol solutions).

The surface finish will be permanently damaged by strong chemicals and solvents such as acetone and trichloroethylene.

Steel wool or other abrasive material should never be used.

Damage caused by the use of unapproved substances or processes will not be warranted. We recommend testing any cleaning solution on a small area of the arm that is not visible, to verify compatibility.

Never submerge or allow liquids to enter the arm. Wipe any cleaning agents off of the arm immediately using a water-dampened cloth. Dry the arm thoroughly after cleaning.

**CAUTION:** GCX makes no claims regarding the efficacy of the listed chemicals or processes as a means for controlling infection. Consult your hospital's infection control officer or epidemiologist. To clean or sterilize mounted instruments or accessory equipment, refer to the specific instructions delivered with those products.

## 11.0 Troubleshooting the VHM-25 Arm

Symptom	Possible Cause	Remedy
Mounted display does not appear level or parallel to the floor.	Channel not plumb. Check with level.	Adjust Channel to plumb, or reinstall Channel.
	Weight of display not compatible with Load Rating of the Arm.	Mount display on arm with compatible Load Rating.
	Swivel hardware loose.	Adjust Swivel Nut (section 6.3).
	Pivot hardware loose.	Adjust Pivot Nut (section 6.4 or 6.5).
	Mounting surface (e.g. wall, side of anesthesia machine, etc.) not structurally sound (does not hold mounting hardware).	Mounting surface must be reinforced or Channel must be relocated.
	Channel loose at mounting surface.	Check for plumb and tighten, or relocate (reinstall) Channel.
	Display may be rotated.	Adjust VESA Rotation Tension (section 6.6).
Mounted display drifts up or down.	Arm not counterbalanced correctly for weight of the display.	Perform counterbalance adjustment (section 6.1).
	Weight of mounted display not compatible with Load Rating of Arm.	Use arm with compatible Load Rating.
Mounted display difficult to move up or down.	Arm not counterbalanced correctly for weight of mounted instrument.	Perform counterbalance adjustment (section 6.1).
Arm pivots too freely.	Pivot tension is too loose.	Adjust Pivot Tension (section 6.4 or 6.5).
Arm is difficult to pivot.	Pivot tension is too tight.	
Display swivels too freely.	Swivel tension is too loose.	Adjust Swivel Tension (section 6.3).
Display is difficult to swivel.	Swivel tension is too tight.	
Display is difficult to tilt.	Tilt tension is too tight.	Adjust tilt tension (section 6.2).
Display will not maintain tilt position.	Tilt tension is too loose.	
Arm inadvertently slides down Channel.	Set Screws (2) in Slide are loose.	Reposition Arm, tighten set screws in slide, and secure adjustable stop (section 4.3).
	Adjustable Stop is loose or missing.	Install or secure adjustable stop (section 4.1).
Display rotates too freely.	VESA rotation is too loose.	Adjust VESA rotation (section 6.6).
Display is difficult to rotate.	VESA rotation is too tight.	